

IEC Connector protection degree IP67 / IP69K, Rewireable, Straight



4762  
IEC Outlet  
black



4762  
without Cover  
white



Set consisting of appliance inlet and connector



See below:  
[Approvals and Compliances](#)

**Description**

- Cord Connectors (Rewireable) : Screw
- Connector , Pin temperature 120 °C , Protection class I
- Push-Pull locking system
- Wire size 0.75-1.5mm², 18AWG-14AWG (0.82-2.08mm²)
- Cable diameter 6.0-10.0mm
- Protection cover as accessory for IP67 / IP69K unplugged
- Complete set consisting of appliance inlet and outlet
- Mating appliance inlet: 4761

**Unique Selling Proposition**

- Waterproofed Cord Connector IP67 / IP69K
- Perfect for use in harsh environments
- Push/Pull technology with interlocking system
- Very simple cable assembly

**Weblinks**

[pdf data sheet](#), [html datasheet](#), [General Product Information](#), [Distributor-Stock-Check](#), [Accessories](#), [Detailed request for product](#), [Microsite](#)

**Technical Data**

Ratings IEC	10A / 250VAC; 50Hz
Ratings UL/CSA	15A / 250VAC; 60Hz
Dielectric Strength	> 1.5kVAC between L-N > 1.5kVAC between L/N-PE (1 min/50Hz)
Allowable Operation Temperature	-25 °C to 120 °C
IP-Protection	from front side IP67 acc. to IEC 60529 / IP69K acc. to ISO 20653
Protection against electric shock	Suitable for appliances with protection class I acc. to IEC 61140
Terminal	Cable
Material: Housing	Thermoplastic, black / white, UL 94V-0

appliance inlet/-outlet	Approved acc. to IEC 60320-1 UL 60320-1, CSA C22.2 no. 60320-1 (For hot conditions) pin-temperature 120 °C, 10A, Protection Class I Shape of connector S15 is SCHURTER specific
-------------------------	--

**Approvals and Compliances**

Detailed information on product approvals, code requirements, usage instructions and detailed test conditions can be looked up in [Details about Approvals](#)

SCHURTER products are designed for use in industrial environments. They have approvals from independent testing bodies according to national and international standards. Products with specific characteristics and requirements such as required in the automotive sector according to IATF 16949, medical technology according to ISO 13485 or in the aerospace industry can be offered exclusively with customer-specific, individual agreements by SCHURTER.

**Approvals**





The approval mark is used by the testing authorities to certify compliance with the safety requirements placed on electronic products.

Approval Reference Type: 4762

Approval Logo	Certificates	Certification Body	Description
	<a href="#">VDE Approvals</a>	VDE	Certificate Number: 40044382
	<a href="#">UL Approvals</a>	UL	UL File Number: E96454

## Product standards

Product standards that are referenced

Organization	Design	Standard	Description
	Designed according to	IEC 60320-1	Appliance couplers for household and similar general purposes
	Designed according to	IEC 60320-1	Appliance couplers for household and similar general purposes
	Designed according to	UL 60320-1	Standard for Attachment Plugs and Receptacles
	Designed according to	CSA C22.2 no. 60320-1	General Use Receptacles, Attachment Plugs, and Similar Wiring Devices





## Application standards

Application standards where the product can be used

Organization	Design	Standard	Description
	Designed for applications acc.	IEC/UL 60950	IEC 60950-1 includes the basic requirements for the safety of information technology equipment.

## Compliances

The product complies with following Guide Lines

Identification	Details	Initiator	Description
	<a href="#">CE declaration of conformity</a>	SCHURTER AG	The CE marking declares that the product complies with the applicable requirements laid down in the harmonisation of Community legislation on its affixing in accordance with EU Regulation 765/2008.
	RoHS	SCHURTER AG	Directive RoHS 2011/65/EU, Amendment (EU) 2015/863
	China RoHS	SCHURTER AG	The law SJ / T 11363-2006 (China RoHS) has been in force since 1 March 2007. It is similar to the EU directive RoHS.
	Halogen Free	SCHURTER AG	SCHURTER strives to offer our customers halogen free products.
	REACH	SCHURTER AG	On 1 June 2007, Regulation (EC) No 1907/2006 on the Registration, Evaluation, Authorization and Restriction of Chemicals 1 (abbreviated as "REACH") entered into force.

## Dimensions [mm]

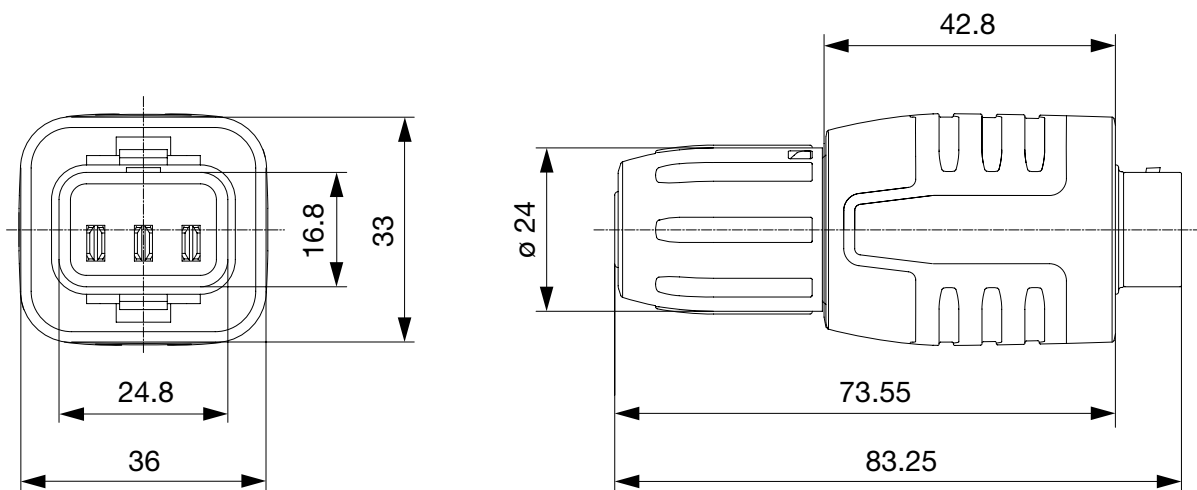

## All Variants

Appliance Inlet	Connector	Kit	Color	Terminals Inlet	Order Number
	●	-	black	-	4312.0003
●	●	1)	black	Quick connect terminals 4.8 x 0.8 mm	4312.0004
●	●	1)	black	Quick connect terminals 6.3 x 0.8 mm	4312.0005
●	●	1)	black	Solder terminals	4312.0006
	●	-	white	-	4312.0010
●	●	1)	white	Quick connect terminals 4.8 x 0.8 mm	4312.0011

Appliance Inlet	Connector	Kit	Color	Terminals Inlet	Order Number
●	●	1)	white	Quick connect terminals 6.3 x 0.8 mm	4312.0012
●	●	1)	white	Solder terminals	4312.0013

1) complete set consisting of appliance inlet and outlet

Most Popular.

Availability for all products can be searched real-time: <https://www.schurter.com/en/Stock-Check/Stock-Check-SCHURTER>

**Packaging unit** 10 Pcs

**Accessories**

**Description**



**Protection cover**  
 Protection cover for waterproof appliance coupler 4761 / 4762

**Mating Inlets/Plugs shuttered**

**Category / Description**



**Appliance Inlet Overview complete**

4761, Mounting: Screw, Solder terminals or quick connect terminals, Appliance Inlet: Approved

4761

[Appliance Inlet further types to 4762](#)