

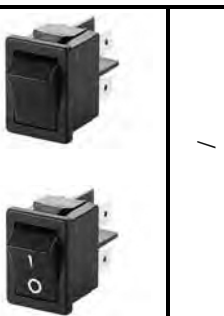













( ) 100 A  
 UL 94 V-0  
 EN 60065 . 14.6

	10E4
	5
( )	100 A
( )	< 100 (1 A 12 .)
( )	> 100 (500 .)
	250 PTI
	IP 40
	-20 °C ... +100 °C -20 °C ... +55 °C
	UL 94 V-0 UL 94 V-2 ( ) 850 °C
	PA PA
	80
	■
	II



		/		10 (4) A 250 ( ) 1E4	6 (4) A 250 ( ) 5E4	12 A 250 ( ) 1/2 HP	12 A 125 ( ) 1/3 HP				EN 60335 .30	
/ (DPST)												
1858,0103			*	*	*	*		3	Ag	*		*
1858,0104			*	*	*	*		3	Ag	*		*
1858,1102			*	*	*	*		4,8	3	Ag	*	*
1858,1103			*	*	*	*		4,8	3	Ag	*	*
1858,1104			*	*	*	*		4,8	3	Ag	*	
1858,1105			*	*	*	*		4,8	3	Ag		10
1858,2202			*	*	*	*		3	Ag	*		*
1858,2204			*	*	*	*		3	Ag	*		*
1858,4202			*	*	*	*		3	Ag	*		*
1858,4205			*	*	*	*		3	Ag	*		*
1858,9202			*	*	*	*		3	Ag	*		

www.peter... (812) 328-2828

WWW.MARQUARDT-SWITCHES.COM

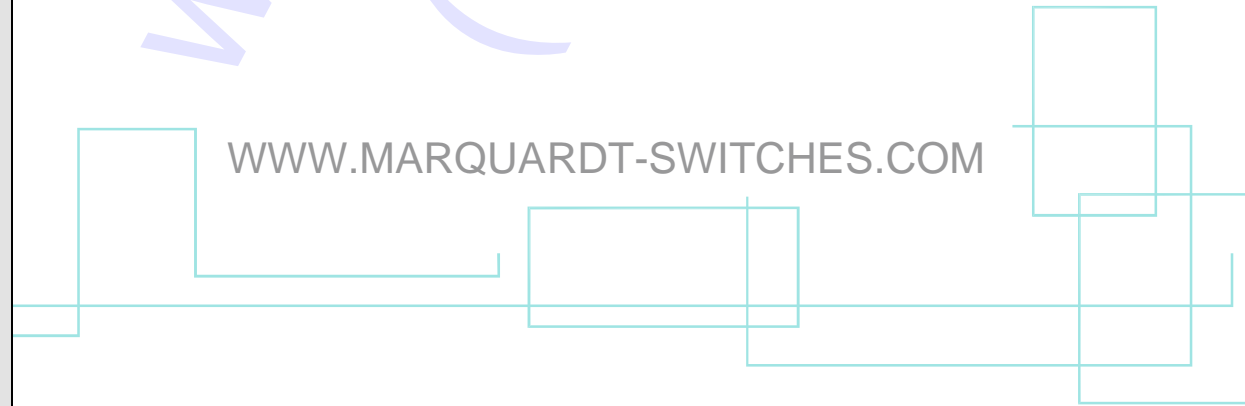

1858 -

10 (4) A 250 ( ) 1E4



1858

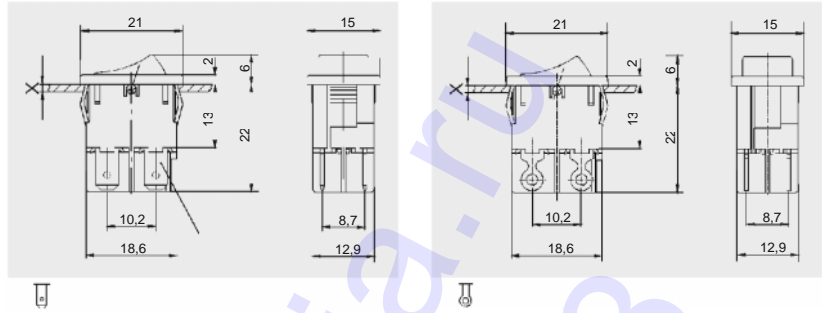

4,8 x 0,8

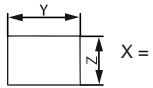

X	Y	*
0,75 ... 1,25	19,2 <sup>-0,1</sup>	12,9 <sup>+0,1</sup>
1,25 ... 2	19,4 <sup>-0,1</sup>	12,9 <sup>+0,1</sup>
2 ... 3	19,8 <sup>-0,1</sup>	12,9 <sup>+0,1</sup>

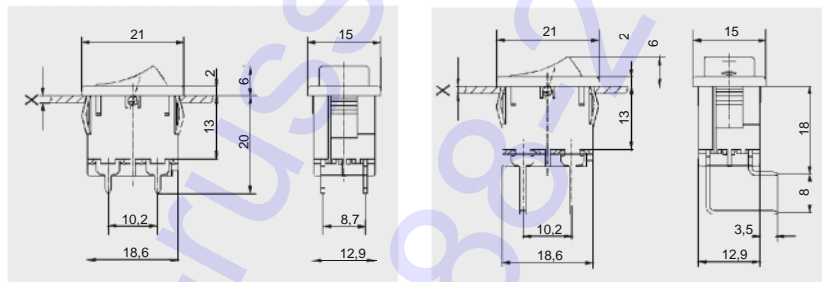

1

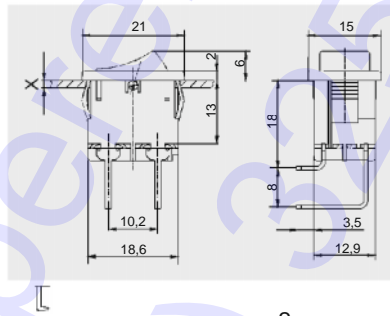

2



203.089.011

