





































100

	10E4	
	5E4 (	1808 1809)
( )	50 A	
	70 A (	Ag / Ag. )
(	) < 100	(1 A 12 .)
(	) > 100	(500 .)
	250 PTI	
	IP 40	
		-20 °C ... +100 °C ... +85 °C (
		-20 °C ... +55 °C
	UL 94 V-2	
	UL 94 V-0 (	)
		850 °C
	PA / PC	
	PA	/ /
	80	
	■	⚠
	II	

















	(SPST)	1800,0102															
		1800,0102	1800,0108	1800,1102	1800,1104	1800,1108	1801,1121	1801,1148	1801,1520	1801,1908	1801,1926	1801,6122	1801,6130	1801,1101	1801,1102	1801,1119	1801,1146
/	/	230	230	230	230	230											
/	/																
12 (4) A 250 ( . ) 1E4							*	*	*	*	*	*	*				
10 (4) A 250 ( . ) 1E4		*	*	*	*	*								*	*	*	*
8 (8) A 250 ( . ) 5E4							*	*	*	*	*	*	*				
6 (4) A 250 ( . ) 5E4		*	*	*	*	*								*	*	*	*
6 (2) A 250 ( . ) 1E4																	
4 (3) A 250 ( . ) 6E3																	
4 (2) A 250 ( . ) 1E4																	
30 12 ( . ) 5E4																	
15 A 250 ( . ) 1 1/2 HP							*	*	*	*	*	*	*				
15 A 125 ( . ) 3/4 HP							*	*	*	*	*	*	*				
10 A 250 ( . ) 1/2 HP																	
10 A 125 ( . ) 1/3 HP																	
6 A 250 ( . ) 1/2 HP		*	*	*	*	*								*	*	*	*
6 A 125 ( . ) 1/4 HP														*	*	*	*
6 A 125 - 250 ( . ) 1/8 HP																	
6 A 125 ( . ) 1/10 HP																	
4 A 250 ( . ) 1/10 HP																	
																	
( ) A				4,8	4,8	4,8	4,8	4,8	4,8	4,8	4,8	4,8	4,8	4,8	4,8	4,8	4,8
							7C	7C	7C	7C	7C	7C	7C	70	70	50	50
		Ag 3	Ag 3	Ag 3	Ag 3	Ag 3	Ag 3	Ag 3	Ag 3	Ag 3	Ag 3	Ag 3	Ag 3	Ag 3	Ag 3	Ag 3	Ag 3
		Ag	Ag	Ag	Ag	Ag	Ag	Ag	Ag	Ag	Ag	Ag	Ag	Ag	Ag	Ag	Ag
EN 60335 cap. 30	"G"									*	*						
		*					*	*	*	*	*			*	*	*	*











												(SPST)	180 1.140:	1801,1601	1801,2106	1801,2402	1801,2702	1801,5102	1801,6101	1801,6102	1801,6115	1801,1151	(SPNC)	1801,1302	1801,1303	(SPNO)	1801,6222	1801,1202		
/																														
12 (4) A 250 ( ) 1E4																														
10 (4) A 250 ( ) 1E4			*	*	*	*	*	*	*	*	*	*	*	*	*	*	*	*	*	*	*	*	*	*	*	*	*	*	*	
8 (8) A 250 ( ) 5E4																														
6 (4) A 250 ( ) 5E4			*	*	*	*	*	*	*	*	*	*	*	*	*	*	*	*	*	*	*	*	*	*	*	*	*	*	*	*
6 (2) A 250 ( ) 1E4																														
4 (3) A 250 ( ) 6E3																														
4 (2) A 250 ( ) 1E4																														
30 12 ( ) 5E4																														
15 A 250 ( ) 1 1/2 HP																														
15 A 125 ( ) 3/4 HP																														
10 A 250 ( ) 1/2 HP																														
10 A 125 ( ) 1/3 HP																														
6 A 250 ( ) 1/2 HP			*	*	*	*	*	*	*	*	*	*	*	*	*	*	*	*	*	*	*	*	*	*	*	*	*	*	*	*
6 A 125 ( ) 1/4 HP			*	*	*	*	*	*	*	*	*	*	*	*	*	*	*	*	*	*	*	*	*	*	*	*	*	*	*	*
6 A 125 - 250 ( ) 1/8 HP																														
6 A 125 ( ) 1/10 HP																														
4 A 250 ( ) 1/10 HP																														
	( ) A		4,8	4,8	4,8	4,8	4,8	4,8	4,8	4,8	4,8	4,8	4,8	4,8	4,8	4,8	4,8	4,8	4,8	4,8	4,8	4,8	4,8	4,8	4,8	4,8	4,8	4,8	4,8	4,8
			Ac 3	Ac 3	Ac 3	Ac 3	Ac 3	Ac 3	Ac 3	Ac 3	Ac 3	Ac 3	Ac 3	Ac 3	Ac 3	Ac 3	Ac 3	Ac 3	Ac 3	Ac 3	Ac 3	Ac 3	Ac 3	Ac 3	Ac 3	Ac 3	Ac 3	Ac 3	Ac 3	Ac 3
EN 60335 cap. 30	"G"																													
				30°		13.2	28.1																							
			*		*		*	*	*	*	*	*	*	*	*	*	*	*	*	*	*	*	*	*	*	*	*	*	*	*

		1801,2202	(SPDT)						(SPDT - Center OFF)						
			1803,1102	1803,1121	1803,2102	1803,5102	1803,6102	1803,6152	1808,1101	1808,1102	1808,1103	1808,1112	1808,1113	1808,1202	1808,1302
/															
12 (4) A 250 ( . ) 1E4															
10 (4) A 250 ( . ) 1E4			*	*	*	*	*								
8 (8) A 250 ( . ) 5E4															
6 (4) A 250 ( . ) 5E4			*	*	*	*	*								
6 (2) A 250 ( . ) 1E4									*	*	*	*	*	*	*
4 (3) A 250 ( . ) 6E3															
4 (2) A 250 ( . ) 1E4		*													
30 12 ( . ) 5E4								*							
15 A 250 ( . ) 1 1/2 HP															
15 A 125 ( . ) 3/4 HP															
10 A 250 ( . ) 1/2 HP				*											
10 A 125 ( . ) 1/3 HP				*											
6 A 250 ( . ) 1/2 HP			*		*	*	*								
6 A 125 ( . ) 1/4 HP			*		*	*	*								
6 A 125 - 250 ( . ) 1/8 HP									*	*	*	*	*	*	*
6 A 125 ( . ) 1/10 HP		*													
4 A 250 ( . ) 1/10 HP		*													
		⌋		⌋	⌋	⌋	⌋	⌋	⌋	⌋	⌋	⌋	⌋	⌋	⌋
			4,8	4,8					4,8	4,8	4,8	4,8	4,8	4,8	4,8
( ) A															
		Ag 3	Ag 3	Ag 3	Ag 3	Ag 3	Ag 3	Au 3	Ag < 3	Ag < 3	Ag < 3	Ag < 3	Ag < 3	Ag < 3	Ag < 3
EN 60335 cap. 30	"G"										*				
			*	*	*		*			*	*			*	*

		(SPDT - Center OFF)										(SPDT )		
		1808,2102	1808,2302	1808,2704	1808,6102	1808,6103	1808,6202	1808,6302	1808,1152	1808,1353	1803,6222	1803,1202	1803,1252	
/														
12 (4) A 250 ( . ) 1E4														
10 (4) A 250 ( . ) 1E4											*			
8 (8) A 250 ( . ) 5E4														
6 (4) A 250 ( . ) 5E4											*			
6 (2) A 250 ( . ) 1E4		*	*	*	*	*	*	*						
4 (3) A 250 ( . ) 6E3												*		
4 (2) A 250 ( . ) 1E4												*		
30 12 ( . ) 5E4									*	*			*	
15 A 250 ( . ) 1 1/2 HP														
15 A 125 ( . ) 3/4 HP														
10 A 250 ( . ) 1/2 HP											*			
10 A 125 ( . ) 1/3 HP											*			
6 A 250 ( . ) 1/2 HP														
6 A 125 ( . ) 1/4 HP														
6 A 125 - 250 ( . ) 1/8 HP		*	*	*	*	*	*	*						
6 A 125 ( . ) 1/10 HP												*		
4 A 250 ( . ) 1/10 HP												*		
( ) A									4,8	4,8		4,8	4,8	
		Aç < 3	Aç < 3	Aç < 3	Aç < 3	Aç < 3	Aç < 3	Aç < 3	AL < 3	AL < 3	Ag 3	Ag 3	Au 3	
EN 60335 cap. 30 "G"														
				29.6										
		*	*		*	*		*			*	*		



		/ (DPST)					(DPNO)		(SPDT)				(DPDT - Center Off)		
		1802,2102	1802,2104	1802,3102	1802,5103	1802,6152	1802,1221	1804,1102	1804,1125	1804,2102	1804,6121	1809,1102	1809,1202	1809,1302	
															
12 (4) A 250 ( . ) 1E4															
10 (4) A 250 ( . ) 1E4		*	*	*	*			*	*	*	*				
8 (8) A 250 ( . ) 5E4															
6 (4) A 250 ( . ) 5E4		*	*	*	*			*	*	*	*				
6 (2) A 250 ( . ) 1E4												*	*	*	
4 (3) A 250 ( . ) 6E3															
4 (2) A 250 ( . ) 1E4							*								
30 12 ( . ) 5E4						*									
15 A 250 ( . ) 1 1/2 HP															
15 A 125 ( . ) 3/4 HP															
10 A 250 ( . ) 1/2 HP									*		*				
10 A 125 ( . ) 1/3 HP									*		*				
6 A 250 ( . ) 1/2 HP		*	*	*	*			*		*					
6 A 125 ( . ) 1/4 HP		*	*	*	*			*		*					
6 A 125 - 250 ( . ) 1/8 HP												*	*	*	
6 A 125 ( . ) 1/10 HP							*								
4 A 250 ( . ) 1/10 HP							*								
			⌋	⌋		⌋		⌋	⌋	⌋	⌋	⌋	⌋	⌋	
	( ) A	50	50	50	50		4,8	4,8	1		4,8	4,8	4,8	4,8	
		3	3	3	3	3	3	3	3	3	3	<3	<3	<3	
		Aç	Aç	Aç	Aç	Al	Aç	Aç	Ag	Ag	Ag	Ag	Ag	Ag	
EN 60335 cap. 30	"G"														
		*	*	*	*		*	*		*		*	*	*	

 		(DPDT - Center OFF)		(DPDT )	
		1809,2101	1809,2102	1804,1225	1804,2202
	/				
12 (4) A 250 ( . ) 1E4					
10 (4) A 250 ( . ) 1E4					
8 (8) A 250 ( . ) 5E4					
6 (4) A 250 ( . ) 5E4					
6 (2) A 250 ( . ) 1E4	*	*			
4 (3) A 250 ( . ) 6E3			*	*	
4 (2) A 250 ( . ) 1E4					
30 12 ( . ) 5E4					
15 A 250 ( . ) 1 1/2 HP					
15 A 125 ( . ) 3/4 HP					
10 A 250 ( . ) 1/2 HP					
10 A 125 ( . ) 1/3 HP					
6 A 250 ( . ) 1/2 HP					
6 A 125 ( . ) 1/4 HP					
6 A 125 - 250 ( . ) 1/8 HP	*	*			
6 A 125 ( . ) 1/10 HP			*	*	
4 A 250 ( . ) 1/10 HP			*	*	
					
	( ) A			1	4,8
		< 3	< 3	3	3
		Ag	Ag	Ag	Ag
EN 60335 . 30	"G"				



	(SPST) /		(SPDT)		(SPST)		(SPNO) /		(SPDT)	
	1806,1402	230	1806,1909	28	1806,1102	1806,6108	1806,2054	(SPDT - Center OFF)	1806,1602	
12 (4) A 250 ( ) 1E4										
10 (4) A 250 ( ) 1E4		*	*		*	*				
8 (8) A 250 ( ) 5E4										
6 (4) A 250 ( ) 5E4		*	*		*	*				
6 (2) A 250 ( ) 1E4								*		
4 (3) A 250 ( ) 6E3										
4 (2) A 250 ( ) 1E4										
30 12 ( ) 5E4							*			
15 A 250 ( ) 1 1/2 HP										
15 A 125 ( ) 3/4 HP										
10 A 250 ( ) 1/2 HP										
10 A 125 ( ) 1/3 HP										
6 A 250 ( ) 1/2 HP		*	*		*	*				
6 A 125 ( ) 1/4 HP		*	*		*	*				
6 A 125 - 250 ( ) 1/8										
6 A 125 ( ) 1/10 HP										
4 A 250 ( ) 1/10 HP										
( ) A		4,8	4,8	4,8		4,8	4,8	4,8		
		Ag 3	Ag 3	Ag 3	Ag 3	Au 3	Ag < 3			
EN 60335 cap. 30 "G"									50 000	
				*						

								
		1807.1102	1807.1108	1807.1126	1807.6103	1807.1115	1807.1111	1806.1508
		230	230	230	230	28	18	230 230
/								
12 (4) A 250 ( . ) 1E4								
10 (4) A 250 ( . ) 1E4								
8 (8) A 250 ( . ) 5E4								
6 (4) A 250 ( . ) 5E4								
6 (2) A 250 ( . ) 1E4								
4 (3) A 250 ( . ) 6E3								
4 (2) A 250 ( . ) 1E4								
30 12 ( . ) 5E4								
15 A 250 ( . ) 1 1/2 HP								
15 A 125 ( . ) 3/4 HP								
10 A 250 ( . ) 1/2 HP								
10 A 125 ( . ) 1/3 HP								
6 A 250 ( . ) 1/2 HP								
6 A 125 ( . ) 1/4 HP								
6 A 125 - 250 ( . ) 1/8 HP								
6 A 125 ( . ) 1/10 HP								
4 A 250 ( . ) 1/10 HP								
								
		4,8	4,8	4,8	4,8	4,8	4,8	4,8
( ) A								
EN 60335 . 30	"G"							
		VD	VD	VD	1805 VDE	40 VDE	40 VDE	
		*	*					



1800, 1801, 1803

1808

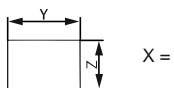

X	Y	*
0,75 ... 1,25	19.2 <sup>-0.1</sup>	12.9 <sup>+0.1</sup>
1,25 ... 2	19.4 <sup>-0.1</sup>	12.9 <sup>+0.1</sup>
2 ... 3	19.8 <sup>-0.1</sup>	12.9 <sup>+0.1</sup>

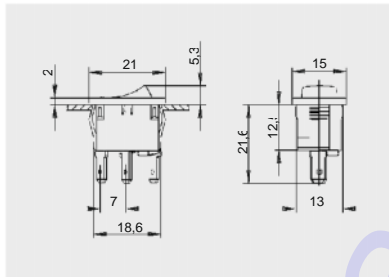

1800

4,8 0,8

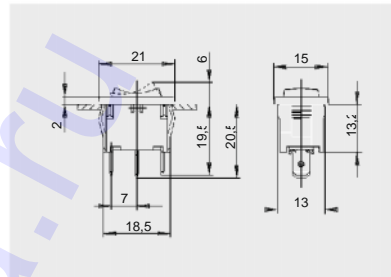

1808

4,8 0,8

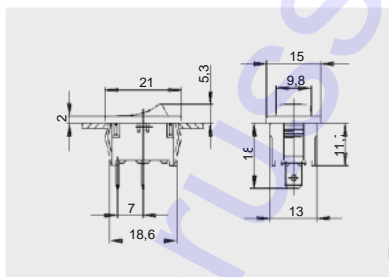

4,8 0,8  
1801 1803

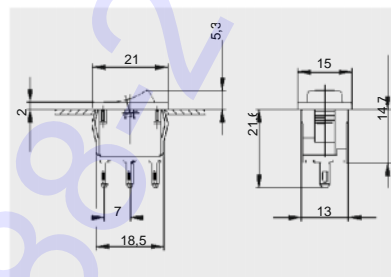

1800

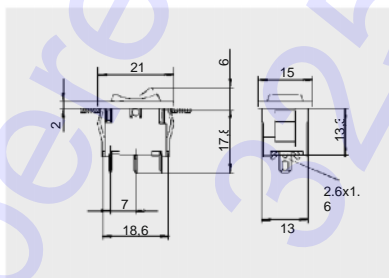

1808



1801 1803

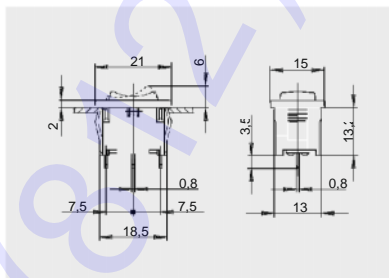

1808



1802, 1804

1805

/

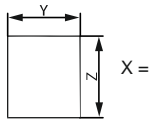

X	Y	*
0,75 ... 1,25	19.2 <sup>-0.1</sup>	21.9 <sup>+0.1</sup>
1,25 ... 2	19.4 <sup>-0.1</sup>	21.9 <sup>+0.1</sup>
2 ... 3	19.8 <sup>-0.1</sup>	21.9 <sup>+0.1</sup>

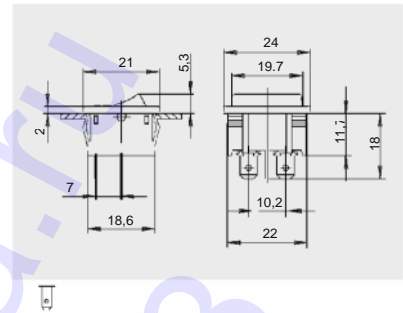
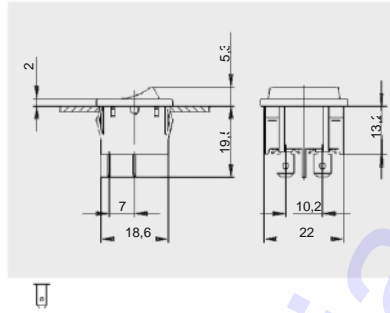

4,8 0,8  
1805

4,8 0,8  
1802 1804

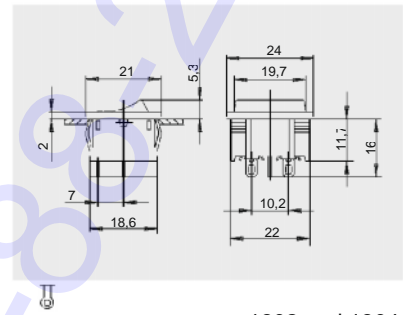
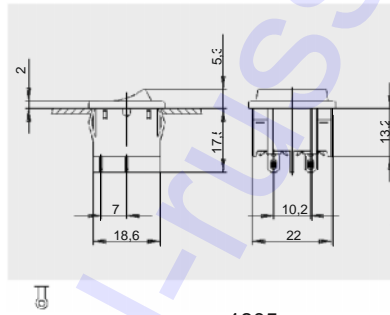

1805

1802 and 1804

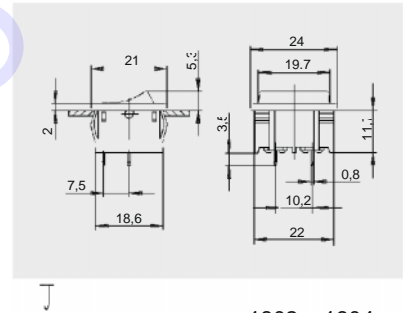
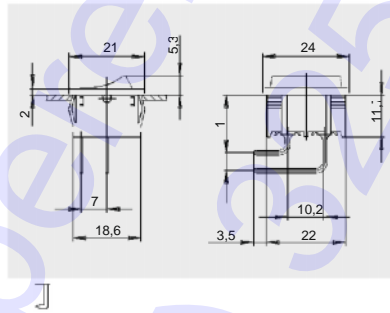

1802 1804

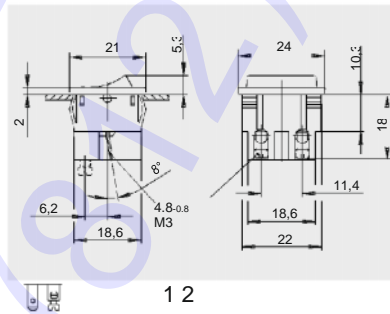

1 2

4,8 0,8

1a 2a  
M3  
1802,3102



1809

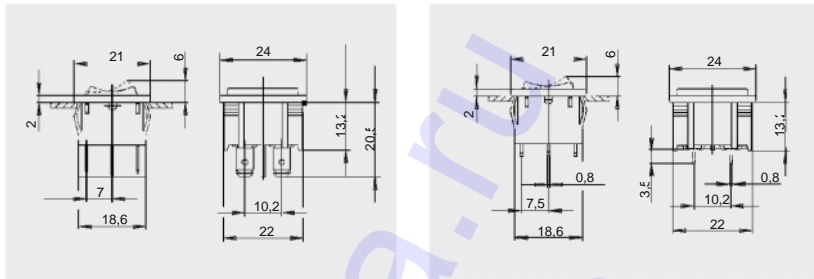

4,8 0,8

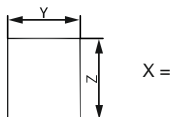

X	Y	*
0,75 ... 1,25	19,2 <sup>-0,1</sup>	21,9 <sup>+0,1</sup>
1,25 ... 2	19,4 <sup>-0,1</sup>	21,9 <sup>+0,1</sup>
2 ... 3	19,8 <sup>-0,1</sup>	21,9 <sup>+0,1</sup>



1806

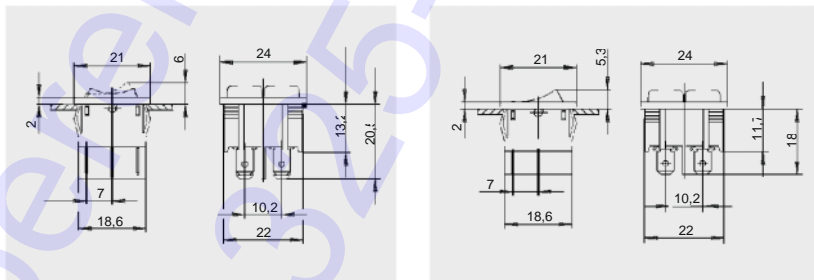

4,8 0,8

1806.2054 1806.1102

4,8 0,8

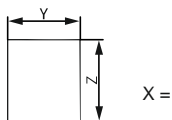

X	Y	*
0,75 ... 1,25	19,2 <sup>-0,1</sup>	21,9 <sup>+0,1</sup>
1,25 ... 2	19,4 <sup>-0,1</sup>	21,9 <sup>+0,1</sup>
2 ... 3	19,8 <sup>-0,1</sup>	21,9 <sup>+0,1</sup>

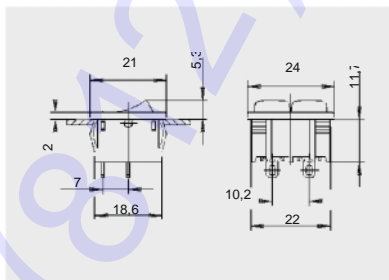

1806,6108

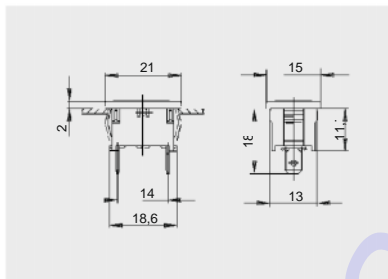

1807

4,8 0,8

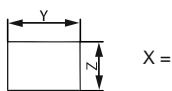

X	Y	*
0,75 ... 1,25	19.2 -0.1	12.9 +0.1
1,25 ... 2	19.4 -0.1	12.9 +0.1
2 ... 3	19.8 -0.1	12.9 +0.1

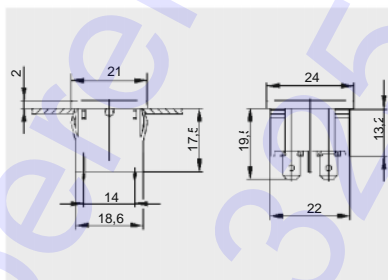

1807

4,8 0,8

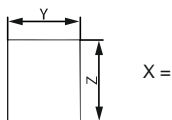

X	Y	*
0,75 ... 1,25	19.2 -0.1	21.9 +0.1
1,25 ... 2	19.4 -0.1	21.9 +0.1
2 ... 3	19.8 -0.1	21.9 +0.1

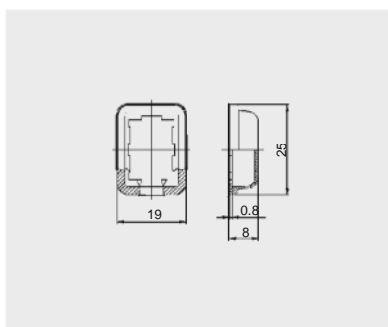

1800, 1801, 1803 1808.

203.089.011

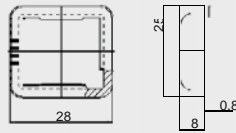

1802, 1804, 1805 1809.

203.090.011

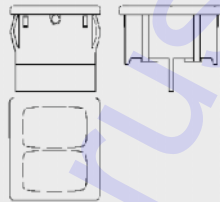

1807 PA

203.007.013 -  
203.007.023 -

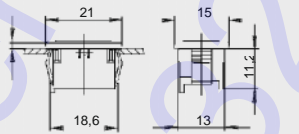

1806 PA

203.086.013