



















































()

	5E4
()	< 100 (1 A 12)
()	> 100 (500)
	250 PTI
	IP 40
	-20 °C ... +85 °C
	-20 °C ... +55 °C
	UL 94 V-2
	850 °C
	PC () / PA
	PA / PA, (
	Cu
	80
	(■) ⚠
	II



					16 (4) A 250 (.) 1E4													
					16 (4) A 250 (.)													
					12 (4) A 250 (.) 1E4													
					12 A 250 (.) 1/2 HP													
					12 A 125 (.) 1/6 HP													
					(SPNC)													
1665.3102	230			*					 6.3 / 2 x 4.8	3	Ag							
					(SPST)													
1662.0201				*					 6.3	3	Ag							
					(SPNC)													
1662.0101				*					 6.3	3	Ag							*
					(SPDT)										
1664.0101				*					 4.8	< 3	Ag							
					16 (4) A 250 (.) 1E4													
					16 (4) A 250 (.)													
					12 (4) A 250 (.) 1E4													
					12 A 250 (.) 1/2 HP													
					12 A 125 (.) 1/6 HP													
					(DPST)													
1660.0201	230			*					 6.3	3	Ag							*
1660.0202	230			*					 6.3	3	Ag							*
1660.3202	230			*					 6.3 / 2 x 4.8	3	Ag							
1660.0222	110			*				*	 6.3	3	Ag							
1661.0220				*		*	*	*	 6.3	3	Ag							
					(DPNO)													
1661.0101				*					 6.3	3	Ag							*
					(DPDT)													
1663.0201				*			*		 4.8	< 3	Ag							
					(DPDT)										
1663.0101				*			*		 4.8	< 3	Ag							*

		/		16 (4) A 250 (.) 1E4	16 (4) A 250 (.)	12 (4) A 250 (.) 1E4	12 A 250 (.) 1/2 HP	12 A 125 (.) 1/6 HP				
1667,0101	230									6,3		
1667,0102	230									6,3		
1667,0104	230									6,3		



1663

1660, 1661

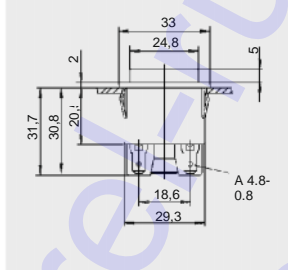

4,8 x .0,8

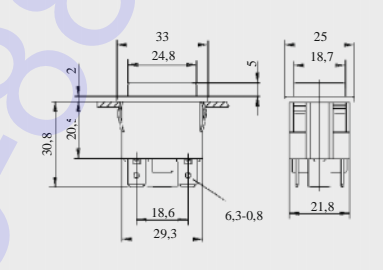

6,3 x .0,8

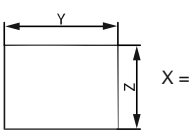

X =

X	Y	Z
0,75 ... 1,0	30 ^{+0.1}	22,2 ^{+0.2}
1,0 ... 1,5	30,2 ^{+0.1}	22,2 ^{+0.2}
1,5 ... 3,0	30,4 ^{+0.1}	22,2 ^{+0.2}

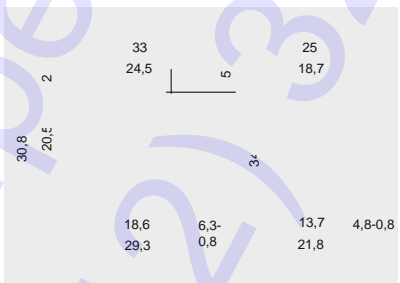

6,3 x 0,8 / 2 x 4,8 x 0,8



1667

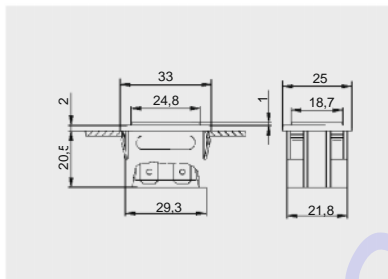

6,3 x 0,8

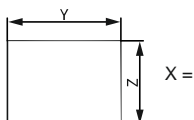

X	Y	*
0,75 ... 1,0	30 ^{+0.1}	22,2 ^{+0.2}
1,0 ... 1,5	30,2 ^{+0.1}	22,2 ^{+0.2}
1,5 ... 3,0	30,4 ^{+0.1}	22,2 ^{+0.2}

EPDM



340.040.011



203.201.011

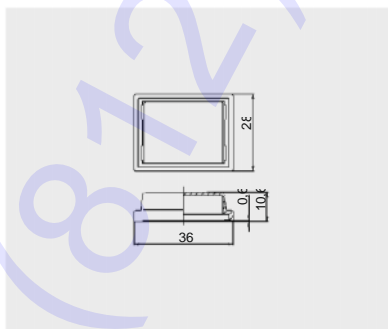

1660, 1662, 1663, 1664, 1665
1667.



203.028.013

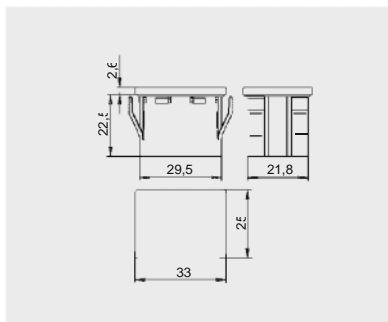

1667 PA

(340.040.011)