



41635C

DIN

(1017).

	DIN 41635 C
()	< 100 (1 A 12 .)
()	> 100 (500 .)
	250 PTI
	IP 00
	-20 °C ... +85 °C ... +120 °C (1014)
	UL 94 V-2 UL 94 HB
	850 °C
	/ PA, /PA/
	(1017.0153)
	PA, /PA
	< 5
	▪
	II



		6 (2) A 250 (.) 25E3	2 (0.5) A 250 (.) 20E4	2 (0.5) A 250 (.) 5E4	2 A, 12 (.) 10E4	1 A, 24 (.) 10E4	0.5 15 5E4	0.1 24 (.) 5E4	30 12 5E4						(FP)	(PI)	
(SPNC)																	
1010.7601		*								9.5 long	Ag	0.25 - 0.6	2.2 ±0.6	0.9 0.4 3.5		1E6	
(SPNO)																	
1010.7401		*								9.5 long	Ag	0.25 - 0.6	2.2 ±0.6	0.9 0.4 3.5		1E6	
1010.7402		*								9.5 long	Ag	0.45 - 1.05	2.2 ±0.6	0.9 0.4 3.5		1E6	
1017.0801							*			9.2 long	CuBe silverplated	0.15 - 0.5	2.2 ±0.6	0 3.2		1E6	*
1017.5701							*			J	CuBe silverplated	0.15 - 0.5	1.4 ±0.6	3.6 0.4		1E6	
1017.0851							*			9.2 long	Au	0.15 - 0.5	2.2 ±0.6	0 3.2		1E6	
(SPDT)																	
1010.9705		*	*							J	Au	0.45 - 1.05	3.8 ±0.6	0.9 6.6 2		10E4	
1010.9752		*	*							J	Ag	0.45 - 1.05	6.9 ±0.6	0.9 9.7 5.1		10E4	
1010.9802		*	*							J	Ag	0.45 - 1.05	3.8 ±0.6	0.9 6.6 2		10E4	
1010.9852		*	*							J	Ag	0.45 - 1.05	6.9 ±0.6	0.9 9.7 5.1		10E4	*
1010.0101		*								6.5 long	Ag	0.25 - 0.6	2.2 ±0.6	0.9 0.4 3.5		1E6	*
1010.3001		*								6.5 long	Ag	0.25 - 0.6	0.9 ±0.6	0.9 3.6 0.2		1E6	*
1010.4402		*								straight	Ag	0.25 - 0.6	1.3 ±0.6	0.9 4.1 0		1E6	*
1010.0304			*							9.5 long	Ag	0.25 - 0.6	2.2 ±0.6	0.9 0.4 3.5		1E6	
1010.2003			*							9.5 long	Au	0.45 - 1.05	2.2 ±0.6	0.9 0.4 3.5		1E6	
1010.4103			*							straight	Au	0.25 - 0.6	2.2 ±0.6	0.9 0.4 3.5		1E6	
1010.6002			*								Au	0.45 - 1.05	11.2 ±0.6	0.9 13.8 9.9		1E6	*
1010.6003			*								Ag	0.25 - 0.6	11.2 ±0.6	0.9 13.8 9.9		1E6	*
1010.7102			*							6.5 long	Ag	0.45 - 1.05	2.2 ±0.6	0.9 0.4 3.5		1E6	
1010.7172			*							6.5 long	Au	0.45 - 1.05	0.9 ±0.6	0.9 3.6 0.2		1E6	
1010.7352			*							9.5 long	Ag	0.45 - 1.05	0.9 ±0.6	0.9 3.6 0.2		1E6	
1010.8102			*							straight	Ag	0.45 - 1.05	2.2 ±0.6	0.9 0.4 3.5		1E6	
1014.6151			*	*							Au	0.3 - 0.8	6.6 ±0.5	0.6 8.6 5.3		50E4	
(SPDT Momentary - Center OFF)																	
1017.0153							*			9.2 long	Au		2.1	0 0.5		1E6	

SLIDE



1010

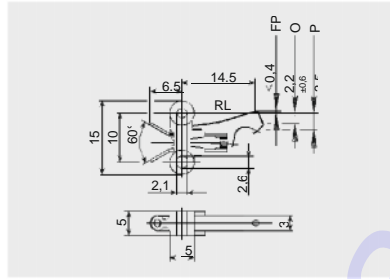

30°

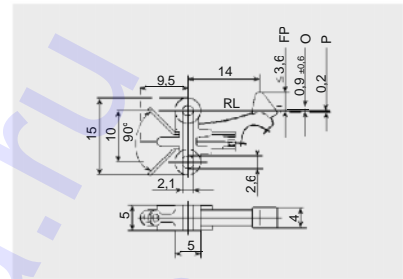

45°

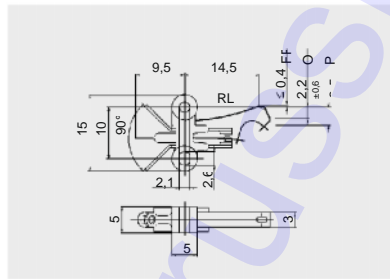

45°

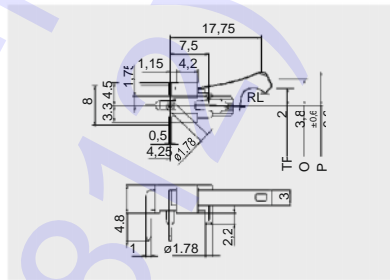
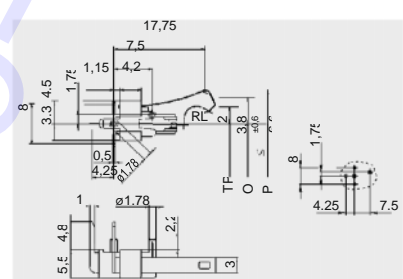
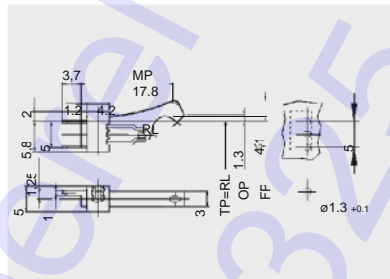
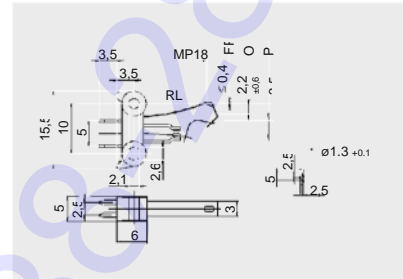

1010,9802

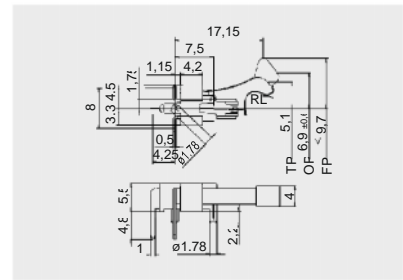

1010,9852



1010

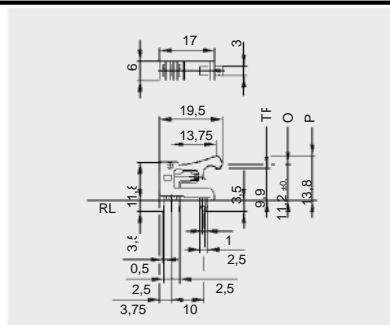



1014

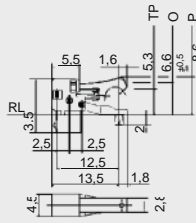

1010,



1017

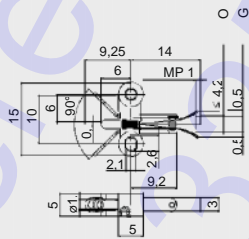
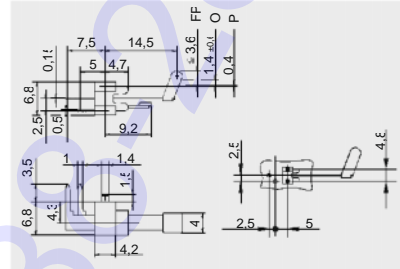
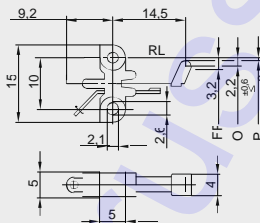

www.perel-1325-8208 (812)